

King1

See further details at <http://web.cecs.pdx.edu/~mpj/snakecube>

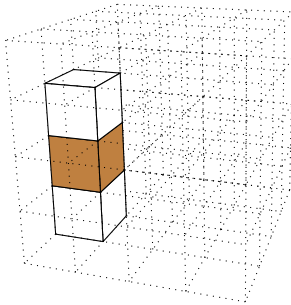

1

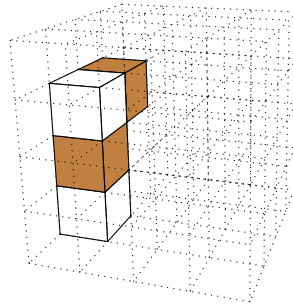

2

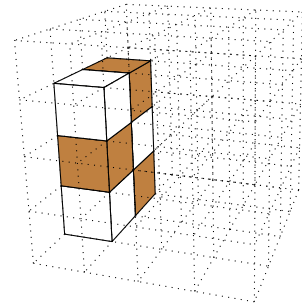

3

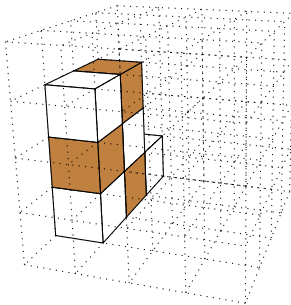

4

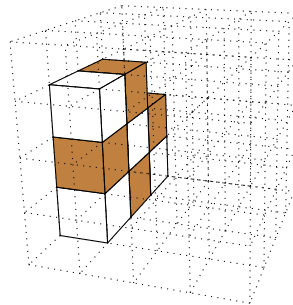

5

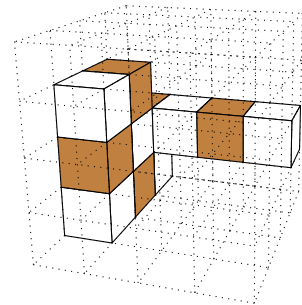

6

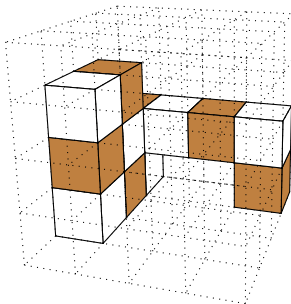

7

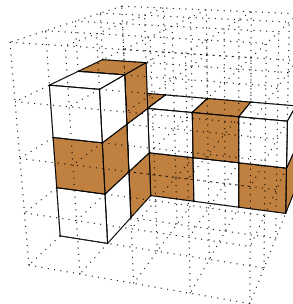

8

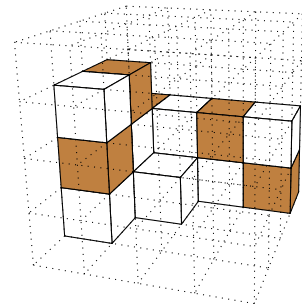

9

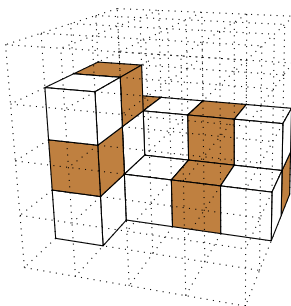

10

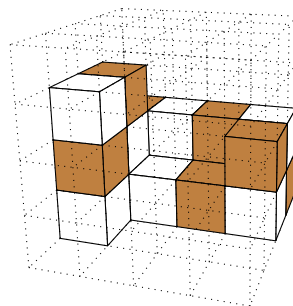

11

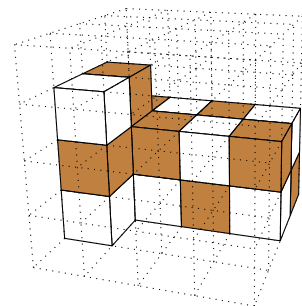

12

King1

See further details at <http://web.cecs.pdx.edu/~mpj/snakecube>

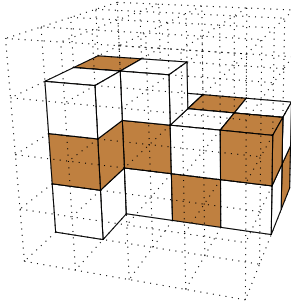

13

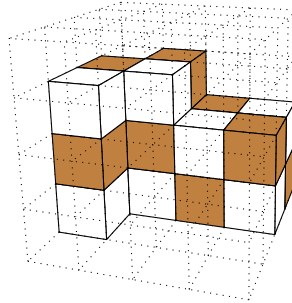

14

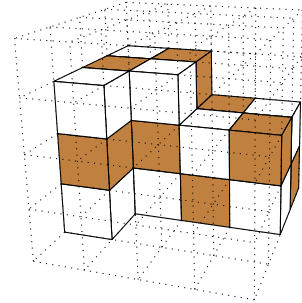

15

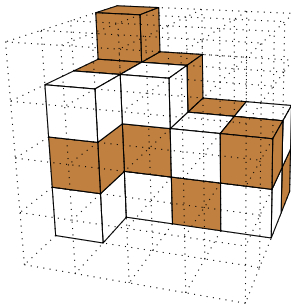

16

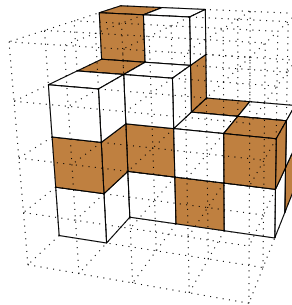

17

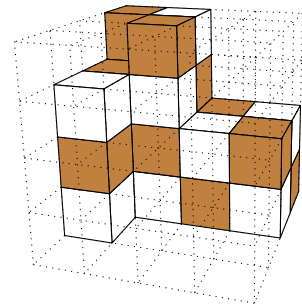

18

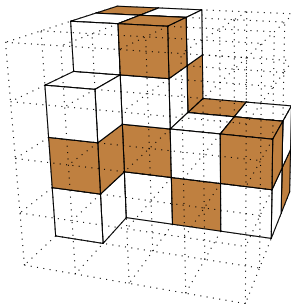

19

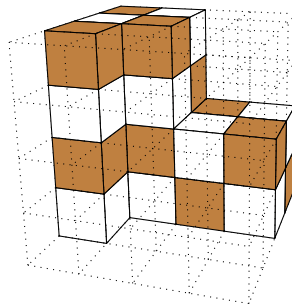

20

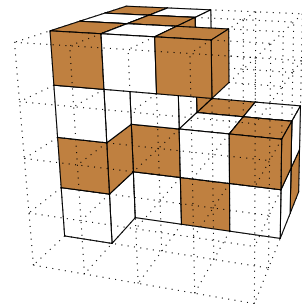

21

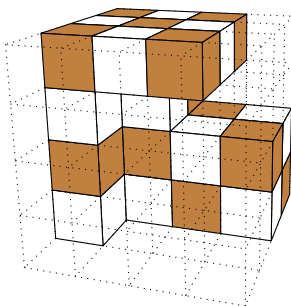

22

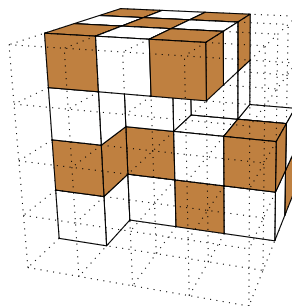

23

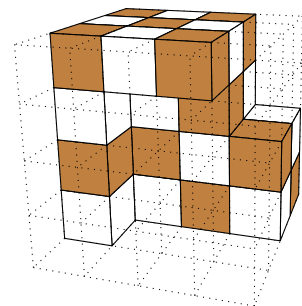

24

King1

See further details at <http://web.cecs.pdx.edu/~mpj/snakecube>

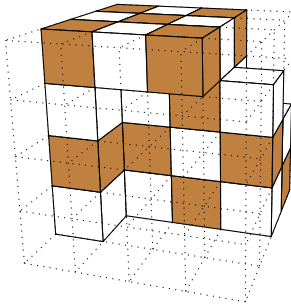

25

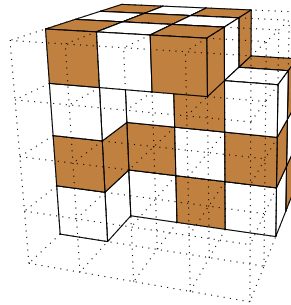

26

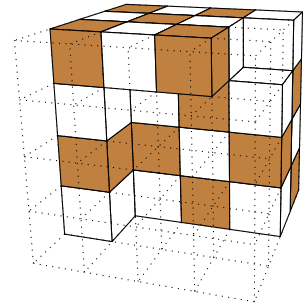

27

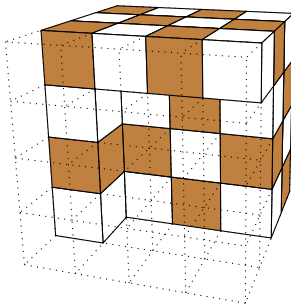

28

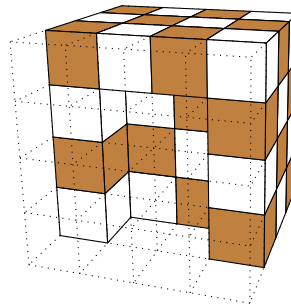

29

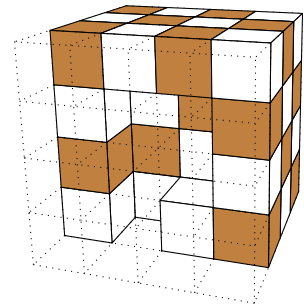

30

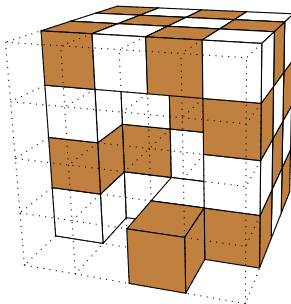

31

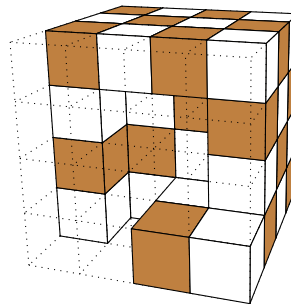

32

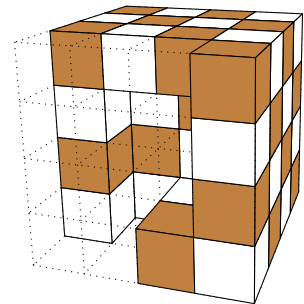

33

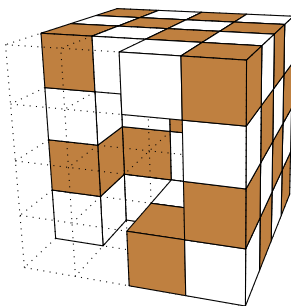

34

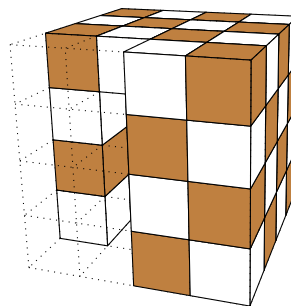

35

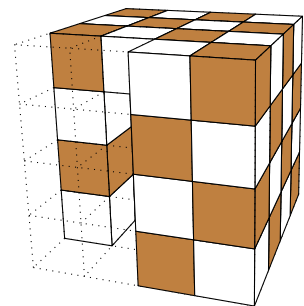

36

King1

See further details at <http://web.cecs.pdx.edu/~mpj/snakecube>

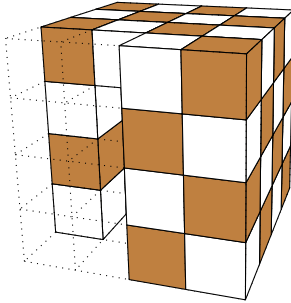

37

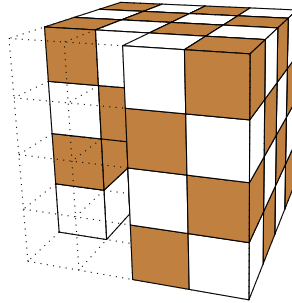

38

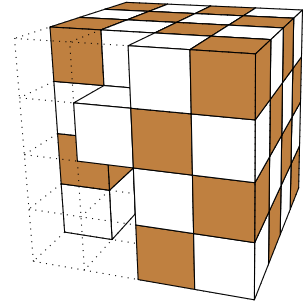

39

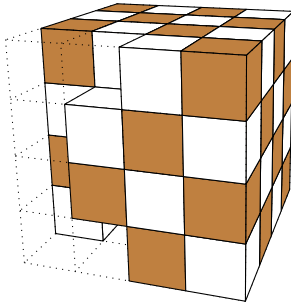

40

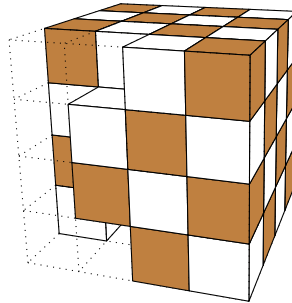

41

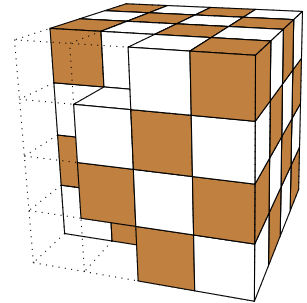

42

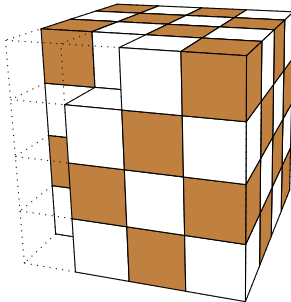

43

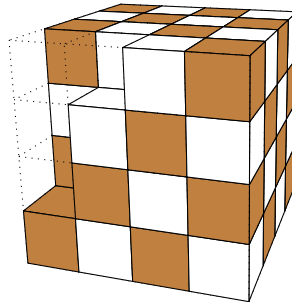

44

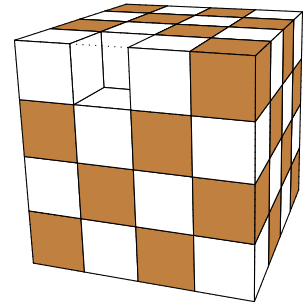

45

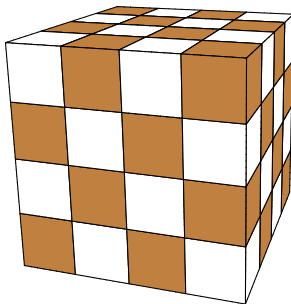

46

King1

See further details at <http://web.cecs.pdx.edu/~mpj/snakecube>

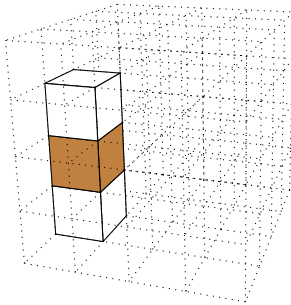

1

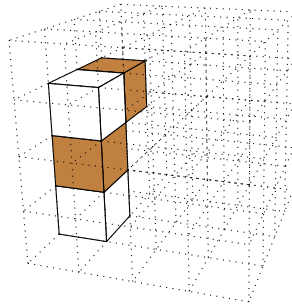

2

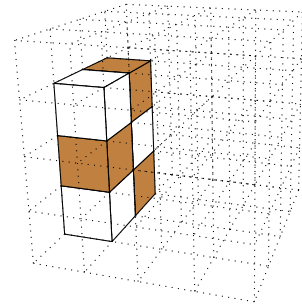

3

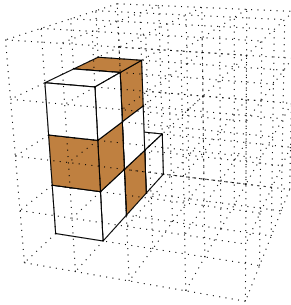

4

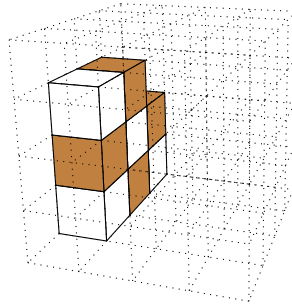

5

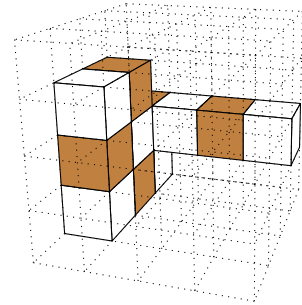

6

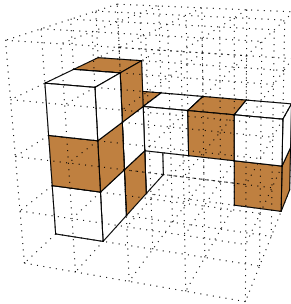

7

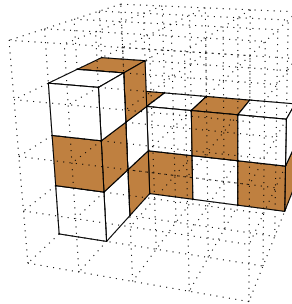

8

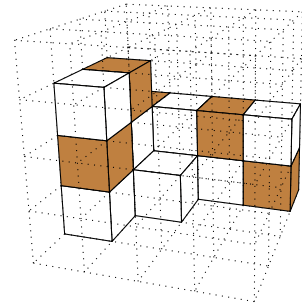

9

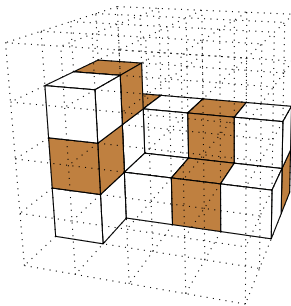

10

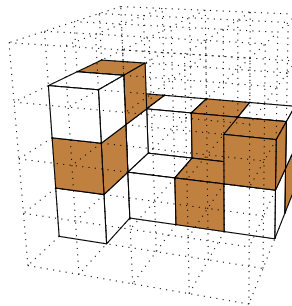

11

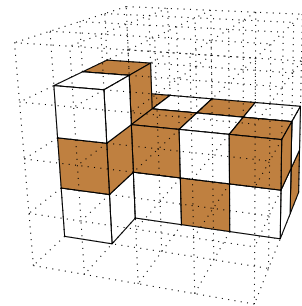

12

King1

See further details at <http://web.cecs.pdx.edu/~mpj/snakecube>

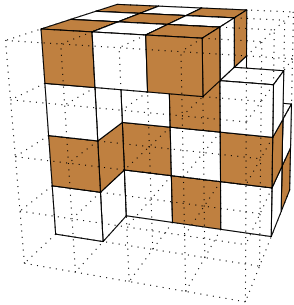

25

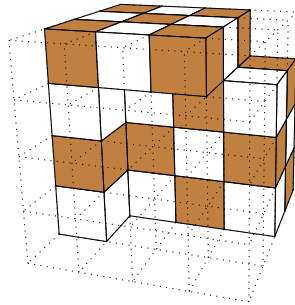

26

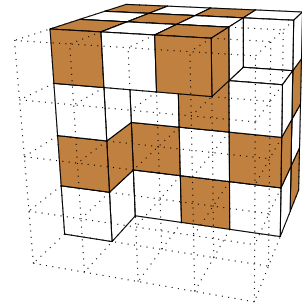

27

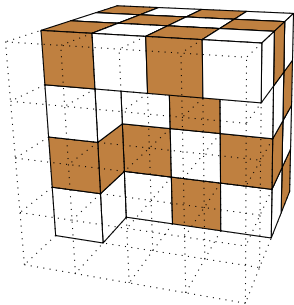

28

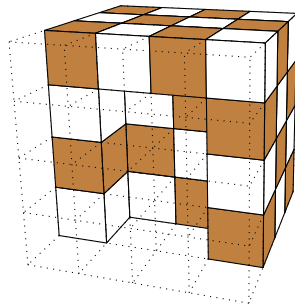

29

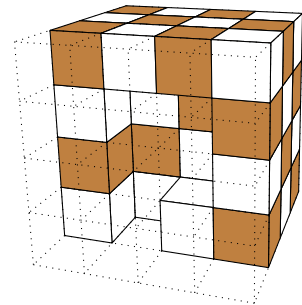

30

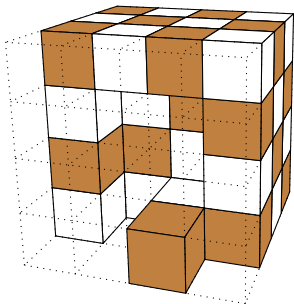

31

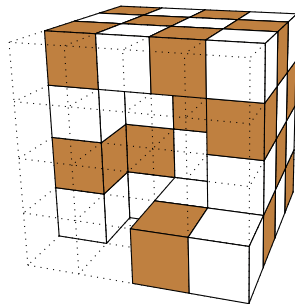

32

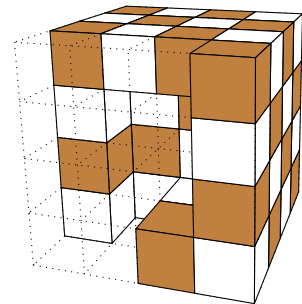

33

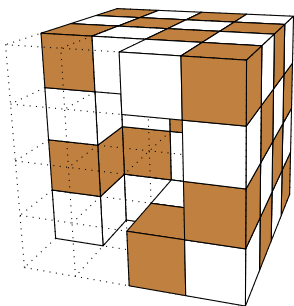

34

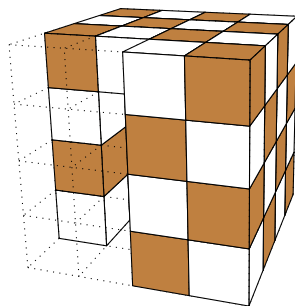

35

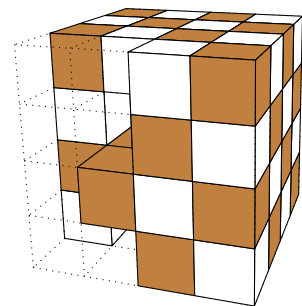

36

King1

See further details at <http://web.cecs.pdx.edu/~mpj/snakecube>

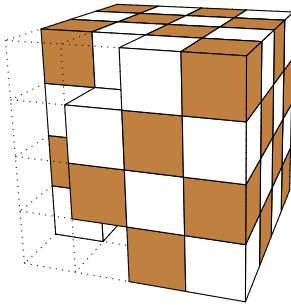

37

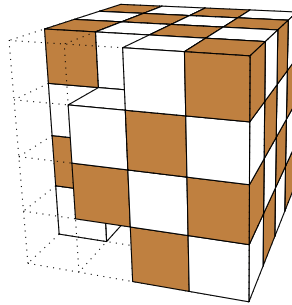

38

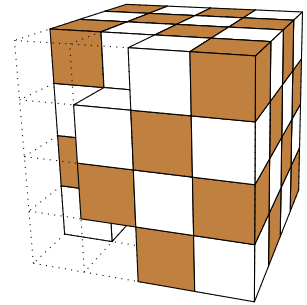

39

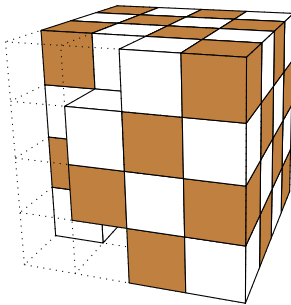

40

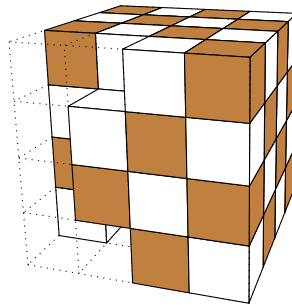

41

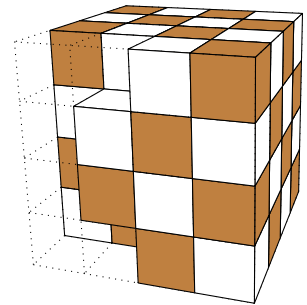

42

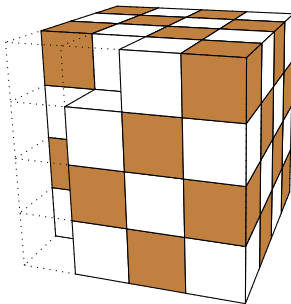

43

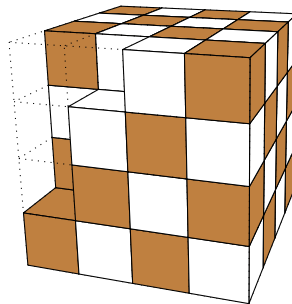

44

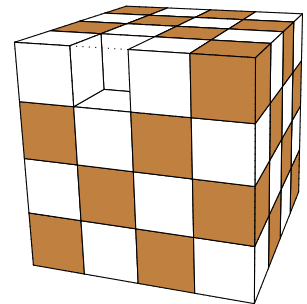

45

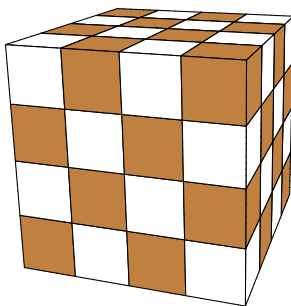

46

King1

See further details at <http://web.cecs.pdx.edu/~mpj/snakecube>

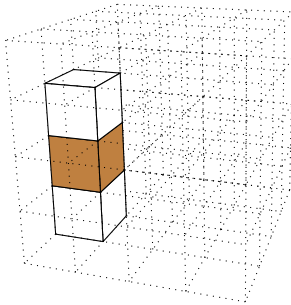

1

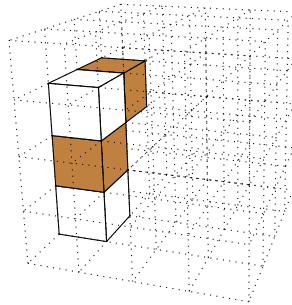

2

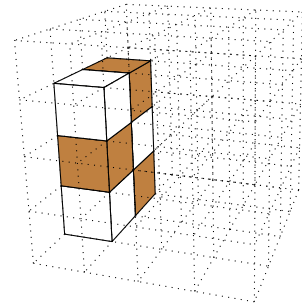

3

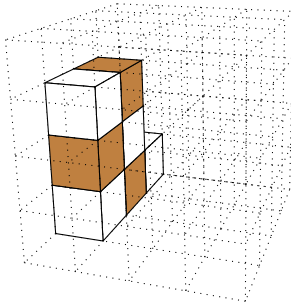

4

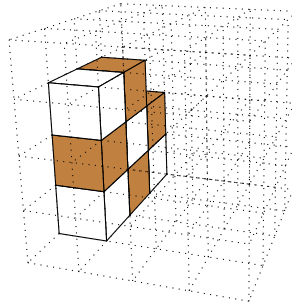

5

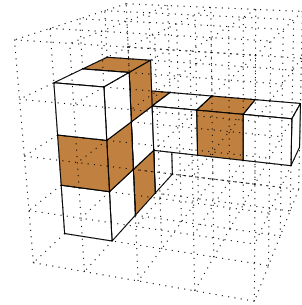

6

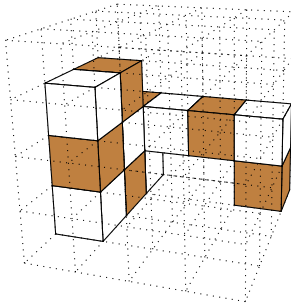

7

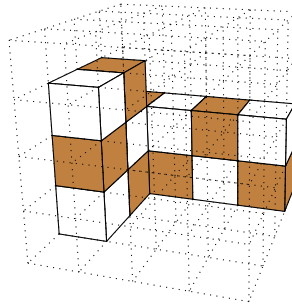

8

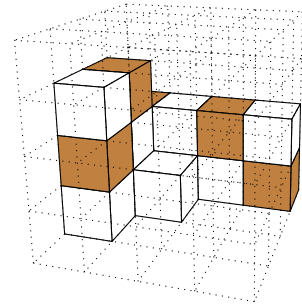

9

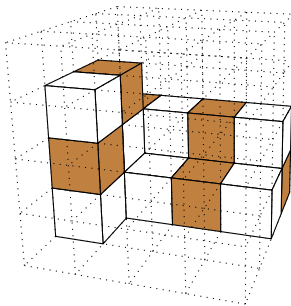

10

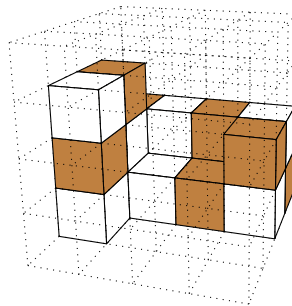

11

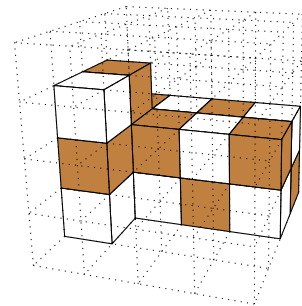

12

King1

See further details at <http://web.cecs.pdx.edu/~mpj/snakecube>

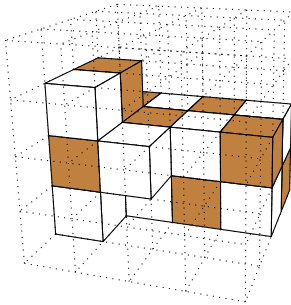

13

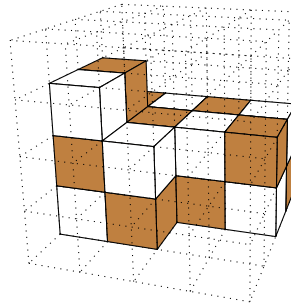

14

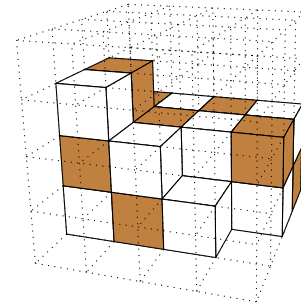

15

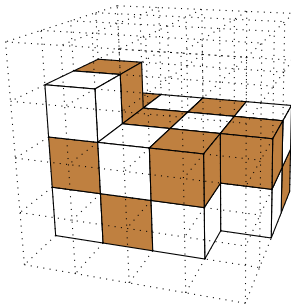

16

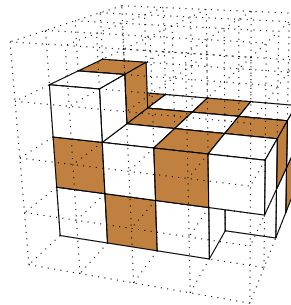

17

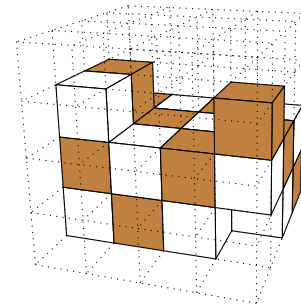

18

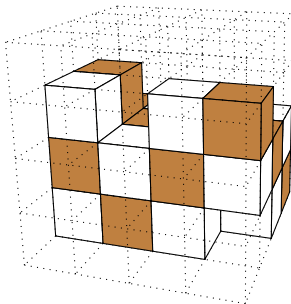

19

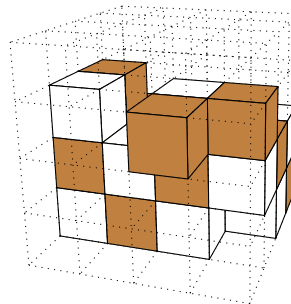

20

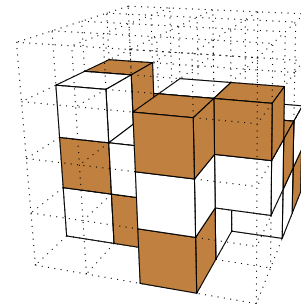

21

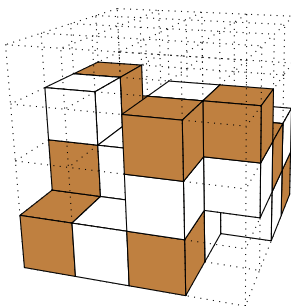

22

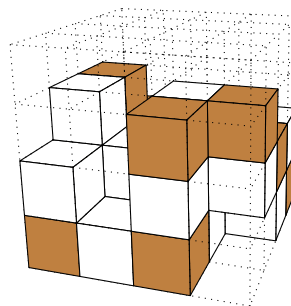

23

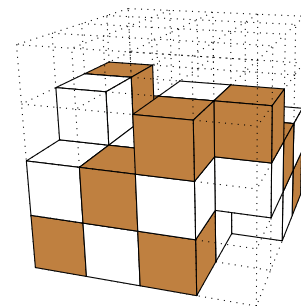

24

King1

See further details at <http://web.cecs.pdx.edu/~mpj/snakecube>

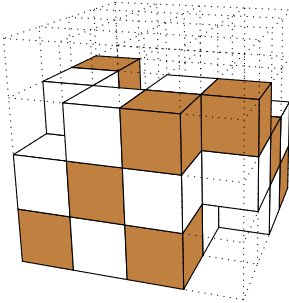

25

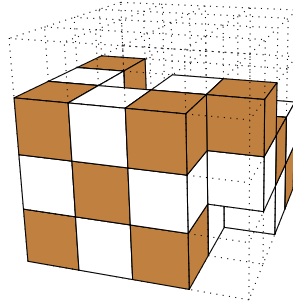

26

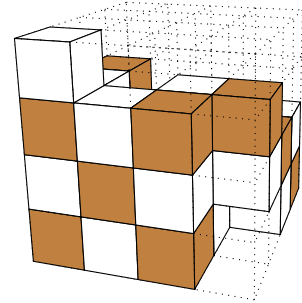

27

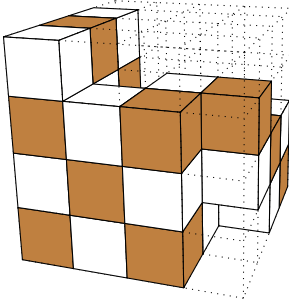

28

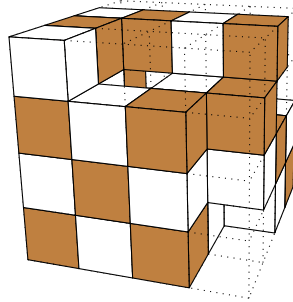

29

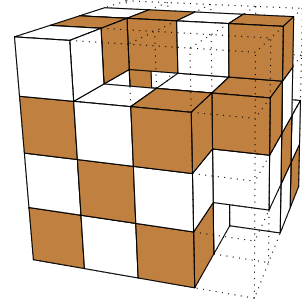

30

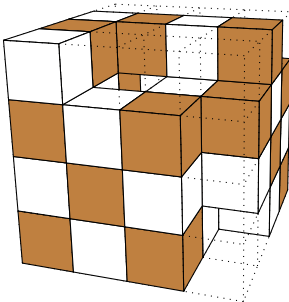

31

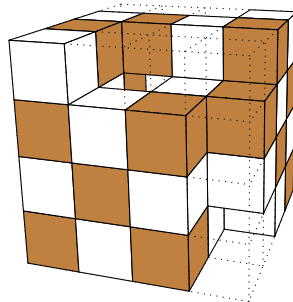

32

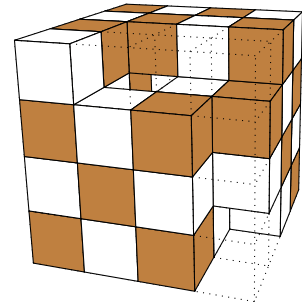

33

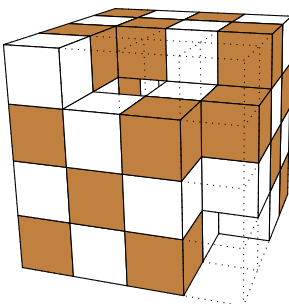

34

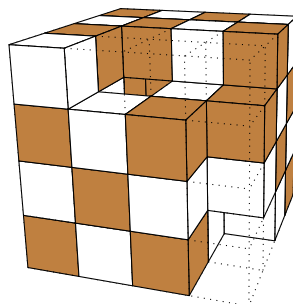

35

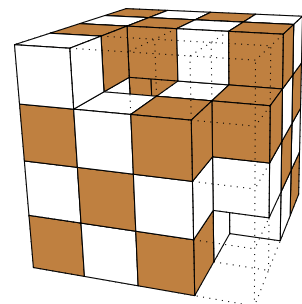

36

King1

See further details at <http://web.cecs.pdx.edu/~mpj/snakecube>

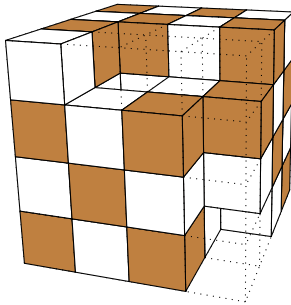

37

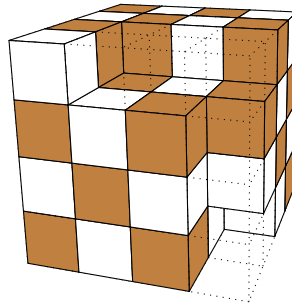

38

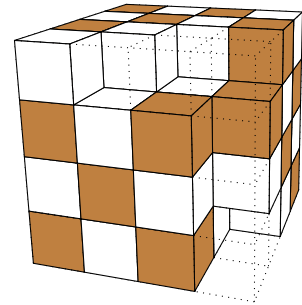

39

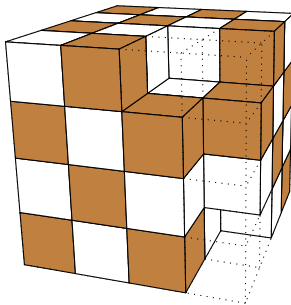

40

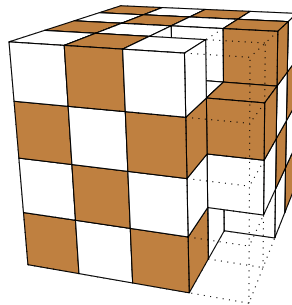

41

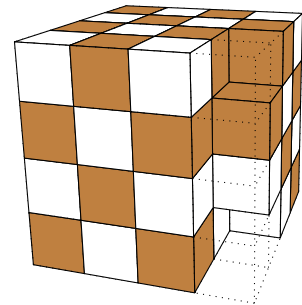

42

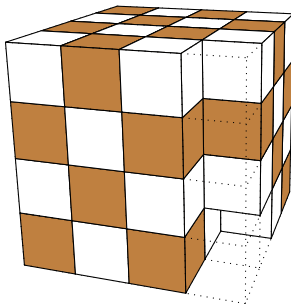

43

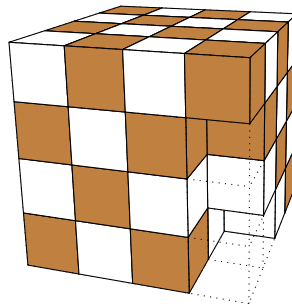

44

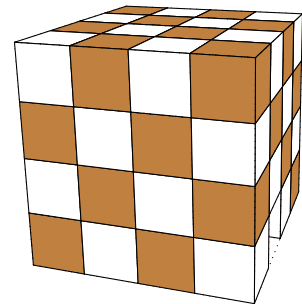

45

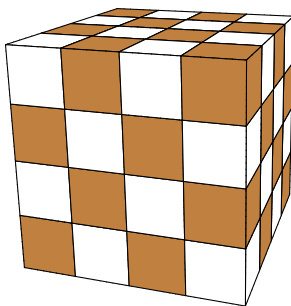

46