Creating Spectrum for Wireless Communications

Bob Brodersen

Berkeley Wireless Research Center
Univ. of California, Berkeley



Creating Spectrum ??

Do we need it?

- Major bandwidth driver is moving from voice to video and data – a 1000-10,000 fold requirement increase
- User base is moving to be a significant fraction of the 6 Billion world population
- Devices (without an attached human) will communicate wirelessly – e.g. Source to HD display with uncompressed video =>10 Gbit/sec

Looks like we need it

- Claim: There is a technological solution to providing this capacity which is based on abandoning the property rights model of “owning” spectrum
- Assertions:
 - » The concept of fixed spectrum allocation has become fundamentally flawed
 - » There are basic misconceptions in the conventional wisdom about the nature of wireless communications

Why has Spectrum Allocation become a Flawed Concept?

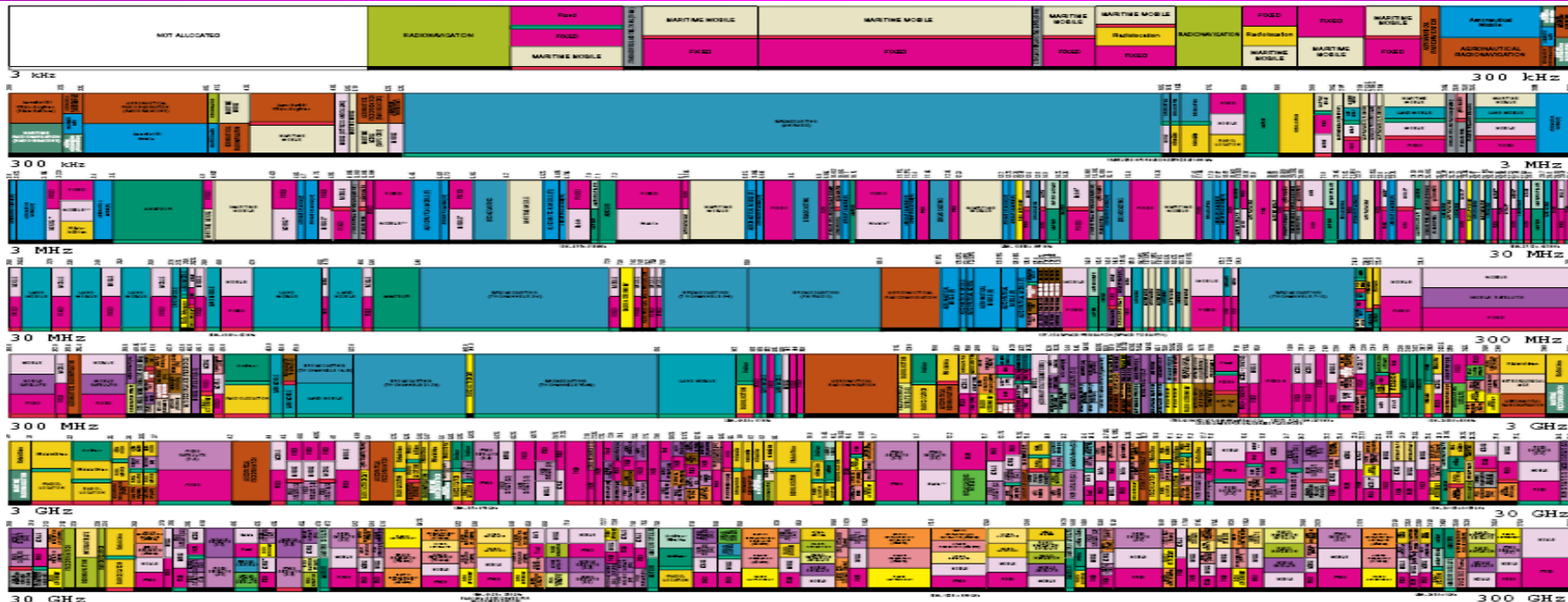

- The applications that will use wireless connectivity are continually changing
- Future radio systems will exploit capabilities that we cannot anticipate today
- Frequency is only one of the 3 dimensions to exploit -time and space give new opportunities

Lets look at the 3-6 GHz band

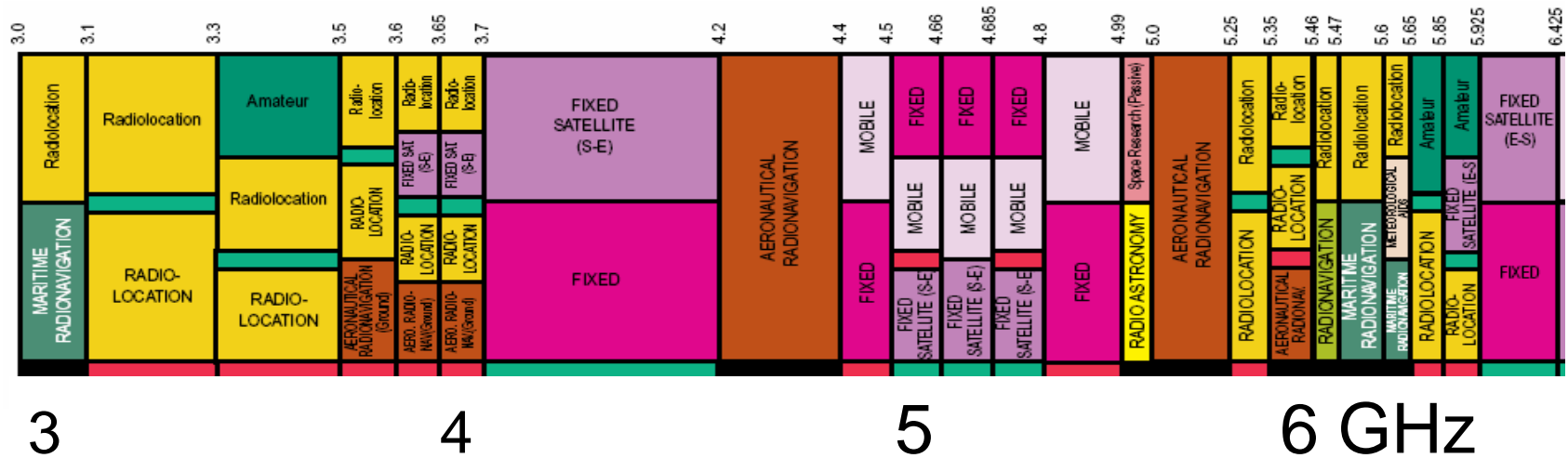

The allocation from 3-6 GHz is typical - seems very, very crowded, but...

The reality is

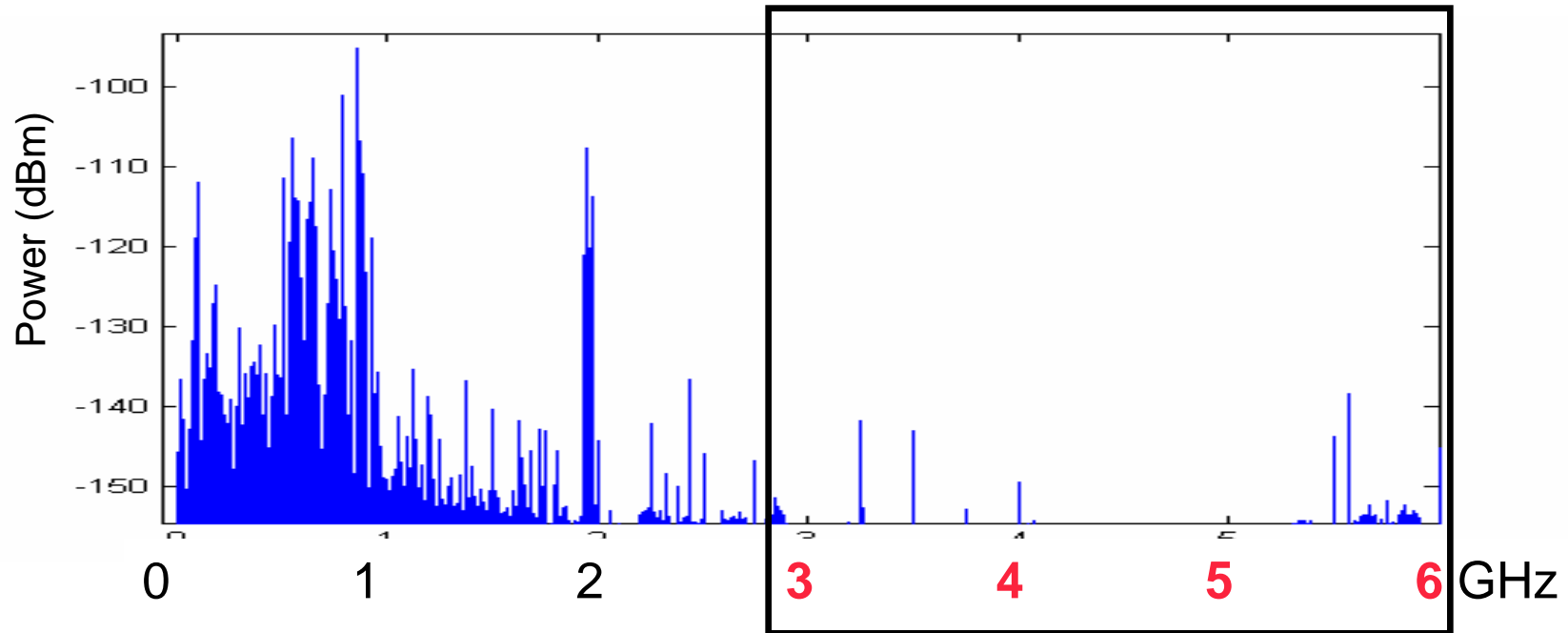

- Even though the spectra is **allocated** it is almost **unused** at any given location
- This is even more true as we go to higher frequencies
- Note that the only significant use is in an unlicensed band

How can we make better use of spectrum?

- Reallocation from Primary Users only solves the problem for a short time, until new applications or new technologies are developed
- We need to share this spectrum without the Primary Users being affected (or even knowing transmissions occurred)

This will “create” new spectrum for future demand...

Methods to Avoid Primary Users

- **Underlay Sharing** – limit power to reduce interference and compensate by the use of wide bandwidths **(UWB Radios)**
- **Overlay Sharing** – Sense primary users and use vacant bands, time slots or locations – “white space”
(Cognitive Radios)
- **New bands** – Use CMOS Technology to exploit unused bands
(60 GHz Radios)

Lets start with UWB...

- “Hide” from the Primary User when occupying the same frequency band
 - » By transmitting at such a **low** power level that it doesn't cause interference
 - » Compensate for the low power by using a **lot** of bandwidth
- Fundamental choices remain on how to best to use the wide bandwidth

Low power and UWB signals

Primary user
Narrowband
(one sine wave)

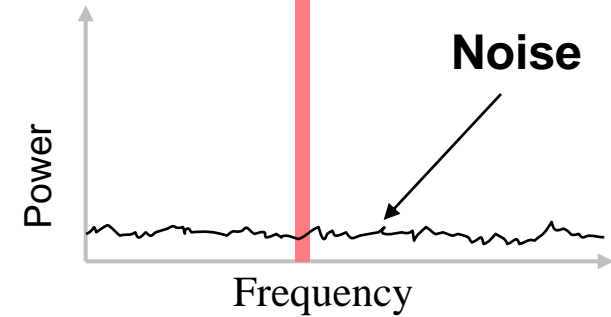
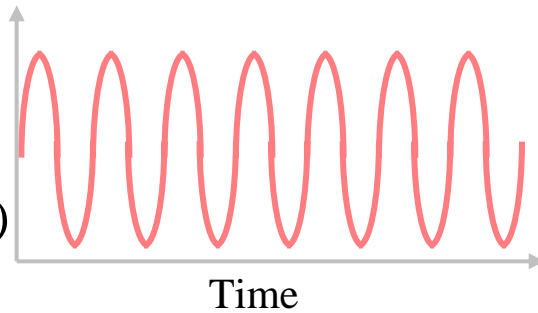

UWB OFDM
(multiple sine waves)

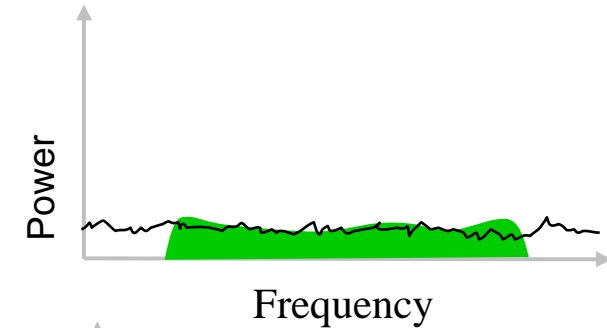
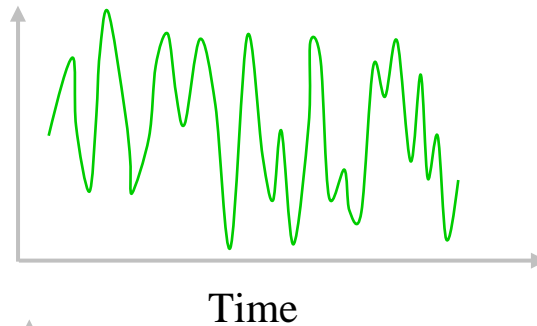

UWB Impulse

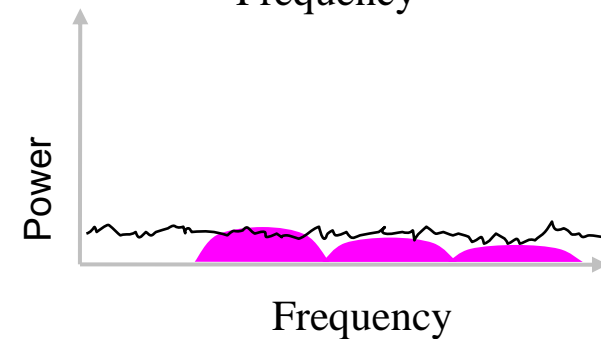
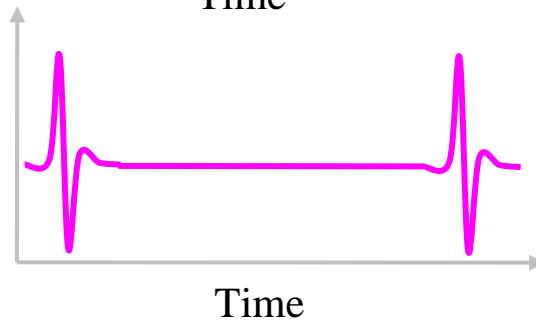

The basic approach is to hide the UWB signal in the noise...

We can now basically ignore the previous spectrum allocation without impact

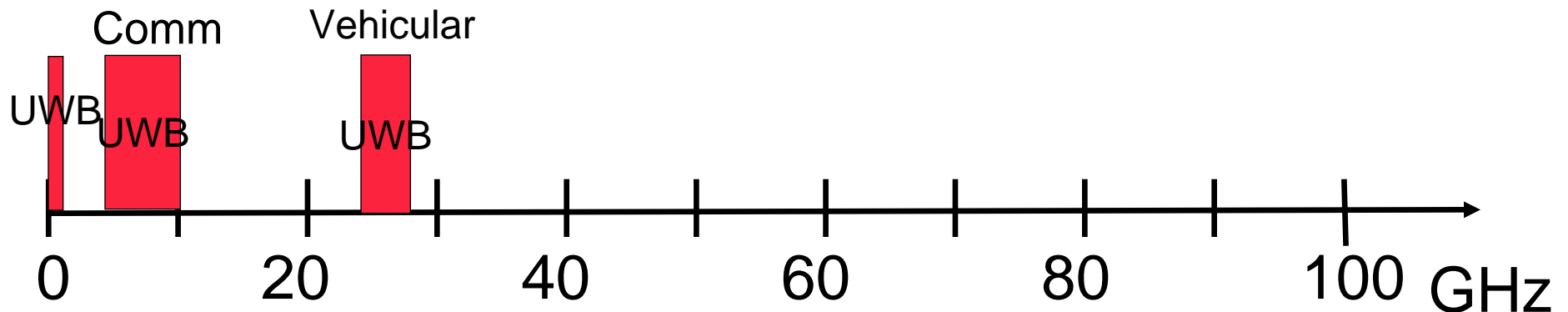

- Unlicensed UWB use is allowed in over **11 GHz** of Bandwidth
- Primary application is for high data rate, short range links
- Chip sets are available for both OFDM and Impulse approaches
- The power limitation is severe, so the viability of this application area is still uncertain

Method 2: The Cognitive Radio Approach

- Basic idea is to first sense to see if a Primary User is present then choose a transmission strategy that doesn't cause interference
- Use all the available degrees of freedom to avoid interference – including time frequency and space

How does a Cognitive Radio operate?

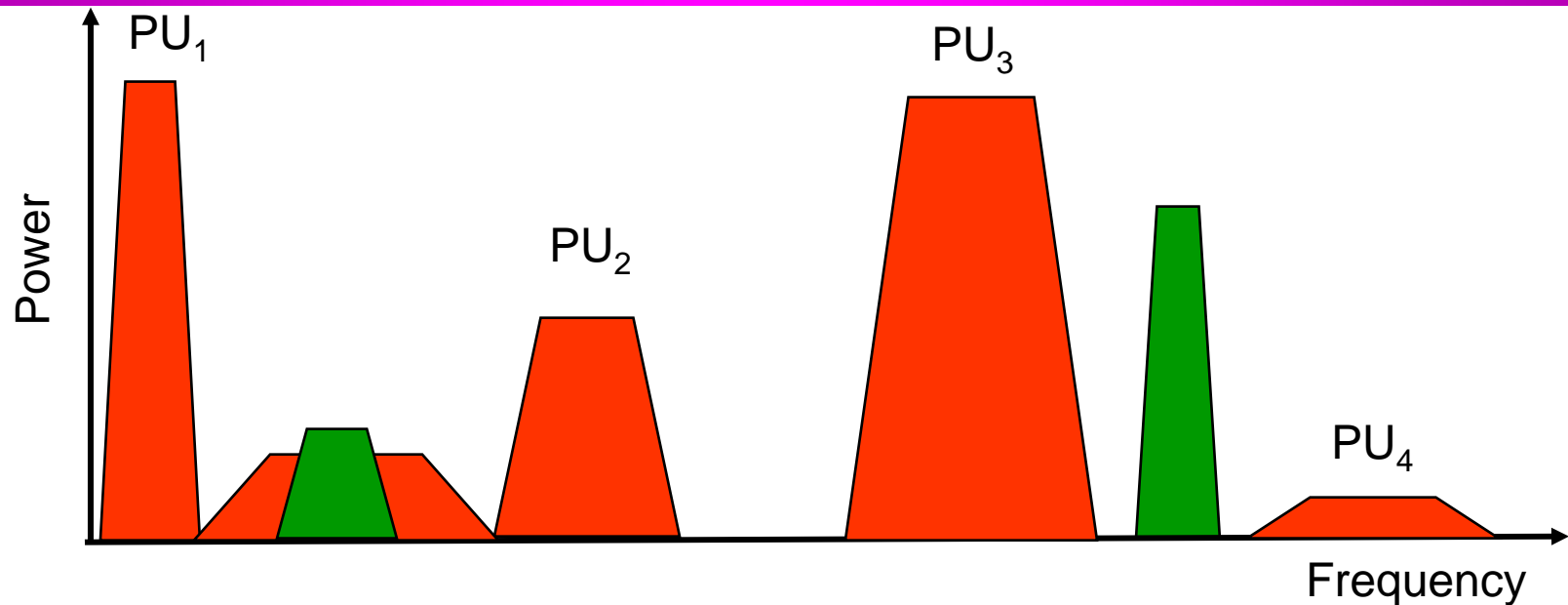

- **Sense** the spectral environment over a wide bandwidth
- **Transmit** in “White Space”
- **Detect** if primary user appears
- **Move** to new white space
- **Adapt** bandwidth and power levels to meet QOS requirements

Sensing Weak Signals

Energy Detector

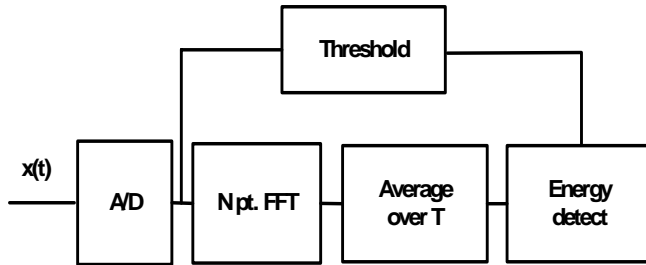

High SNR

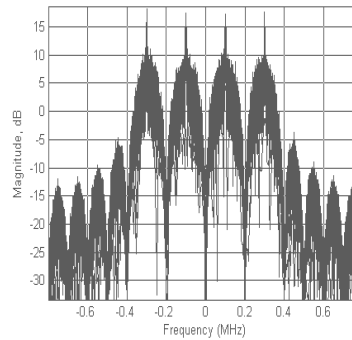

Low SNR

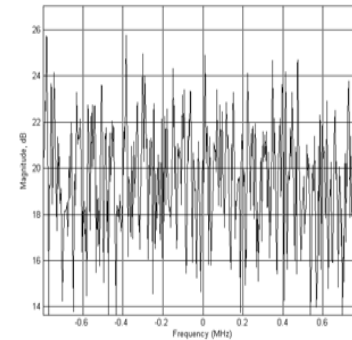

Cyclostationary Detector

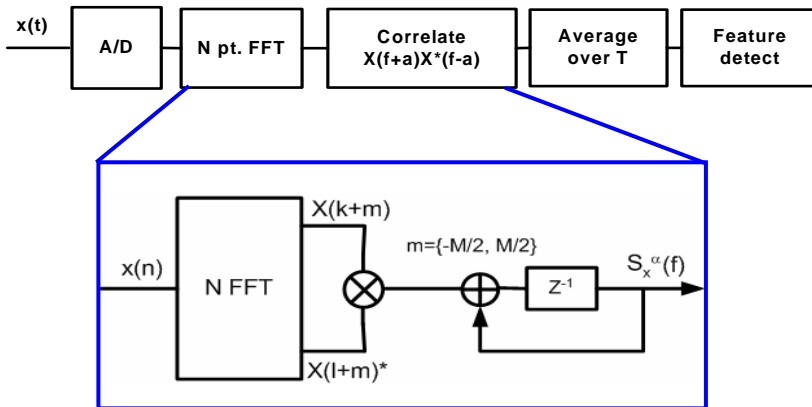

Spectrum density

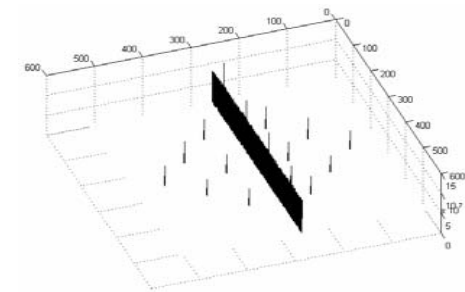
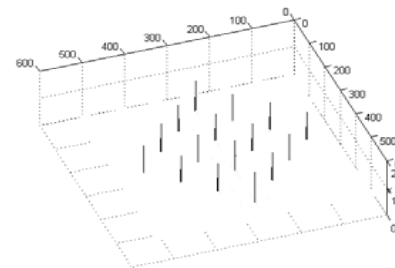

Spectral correlation

A new radio functionality – requires new algorithms and understanding

Exploit Spatial dimension

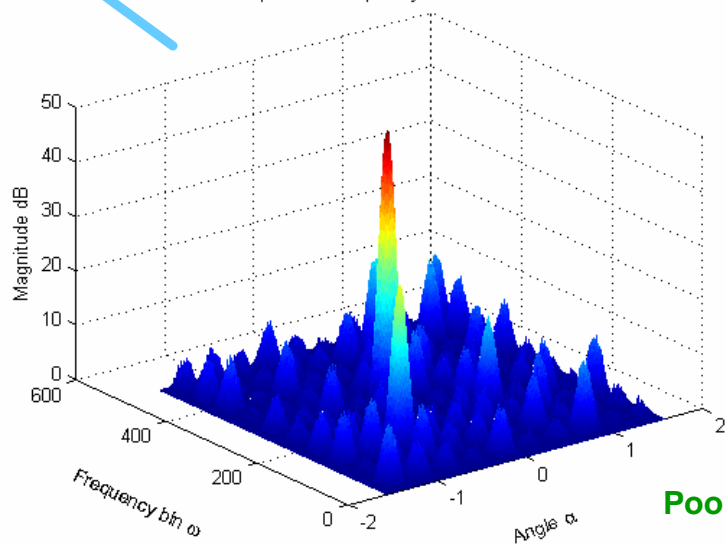
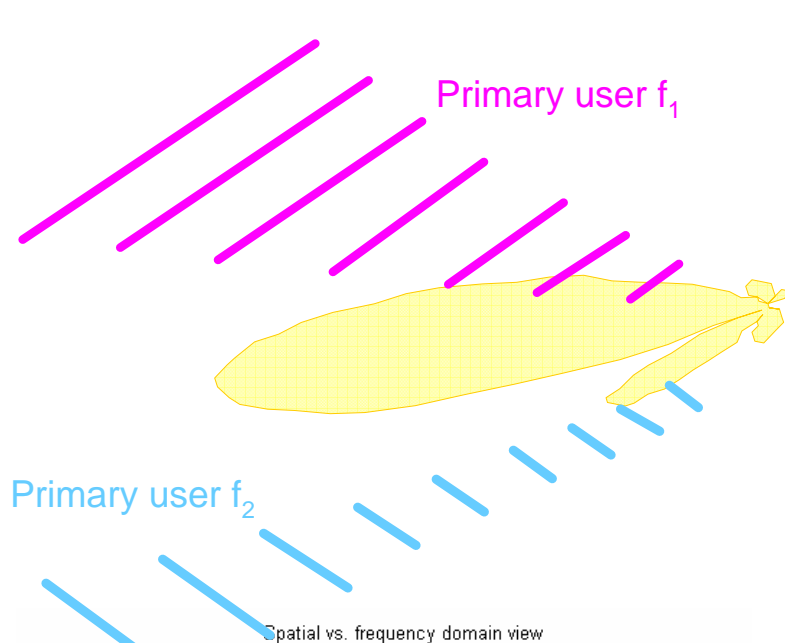

Poon, Tse, Brodersen[2004]

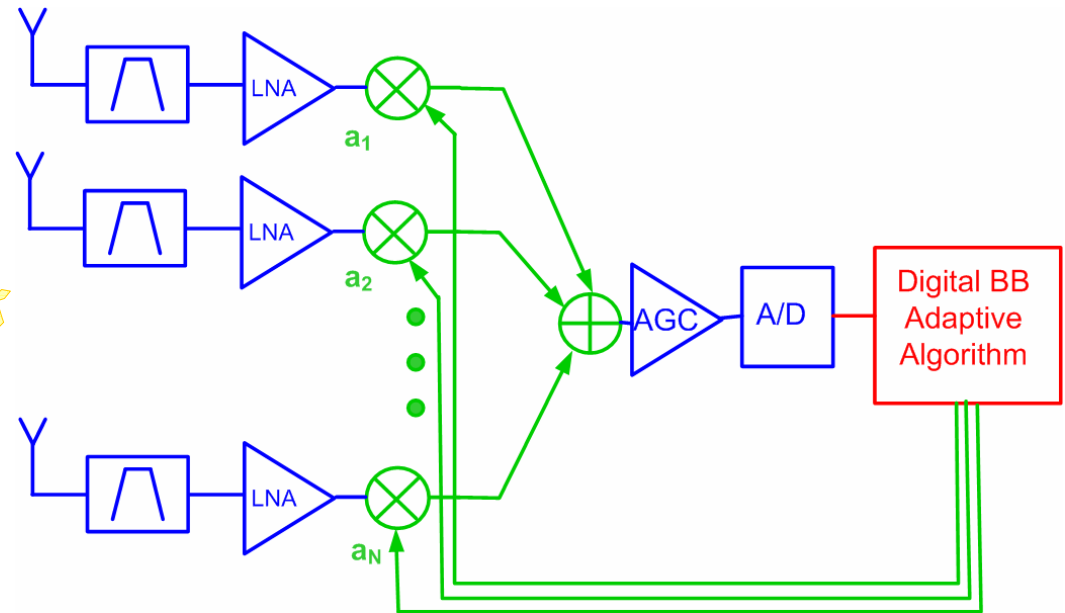

- Use it to reject strong interfering signals
- Another way to avoid primary users

Regulators see the advantages

According to the FCC:

“We recognize the importance of new cognitive radio technologies, which are likely to become more prevalent over the next few years and which hold tremendous promise in helping to facilitate more effective and efficient access to spectrum”

Federal Communications Commission,
ET Docket No. 03-108, Dec 30th 2003

Things are happening (recent news release)...

TV Spectrum to Be Opened for Other Uses

The FCC agrees to give technology companies some access to the white space between channels for wireless devices.

By Jim Puzzanghera, Times Staff Writer

October 13, 2006

WASHINGTON — The Federal Communications Commission on Thursday struck a compromise that would **give technology companies some access to the white space between television channels** while addressing broadcasters' fears that new gadgets could interfere with their signals.

A major telecommunications bill pending in the U.S. Senate **calls for the vacant white space spectrum to be opened to unlicensed devices** and directs the FCC to develop rules for use of the spectrum within 270 days of the bill's passage.

The Opportunity of Millimeter Wave Bands

- Millimeter radios operate in the 30-300 GHz range (1-10 mm wavelength)
- There are large amounts of unused and unlicensed spectra – so why isn't it used?
 - » Misconceptions about path loss and propagation at 60 GHz
 - » The technology to process signals at 60 GHz was expensive

Millimeter wave radios

- Misconception 1: As you go up in frequency there is an inherent “path loss” that reduces range
 - » This comes from only considering omnidirectional antennas which have a size that is inverse with carrier frequency
 - » Solution is keep area constant using directional antennas - then the received signal **increases** with frequency

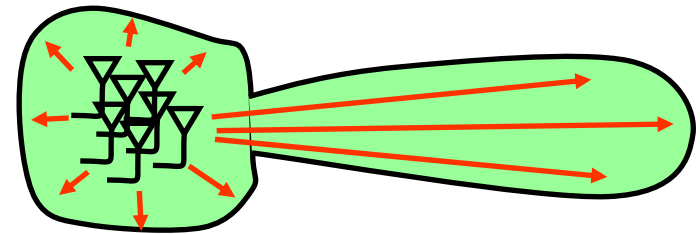
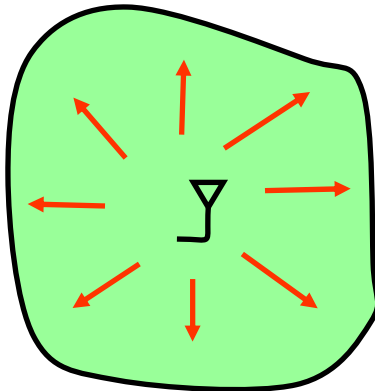

Millimeter wave radios

- Misconception 2: Only line of sight transmission is possible
 - » millimeter waves reflect like lower frequency waves, so adaptive directional antenna arrays can choose strongest signal
 - » millimeter waves have higher material penetration loss, but this can be compensated for with the higher power and antenna gain

60 GHz is particularly interesting

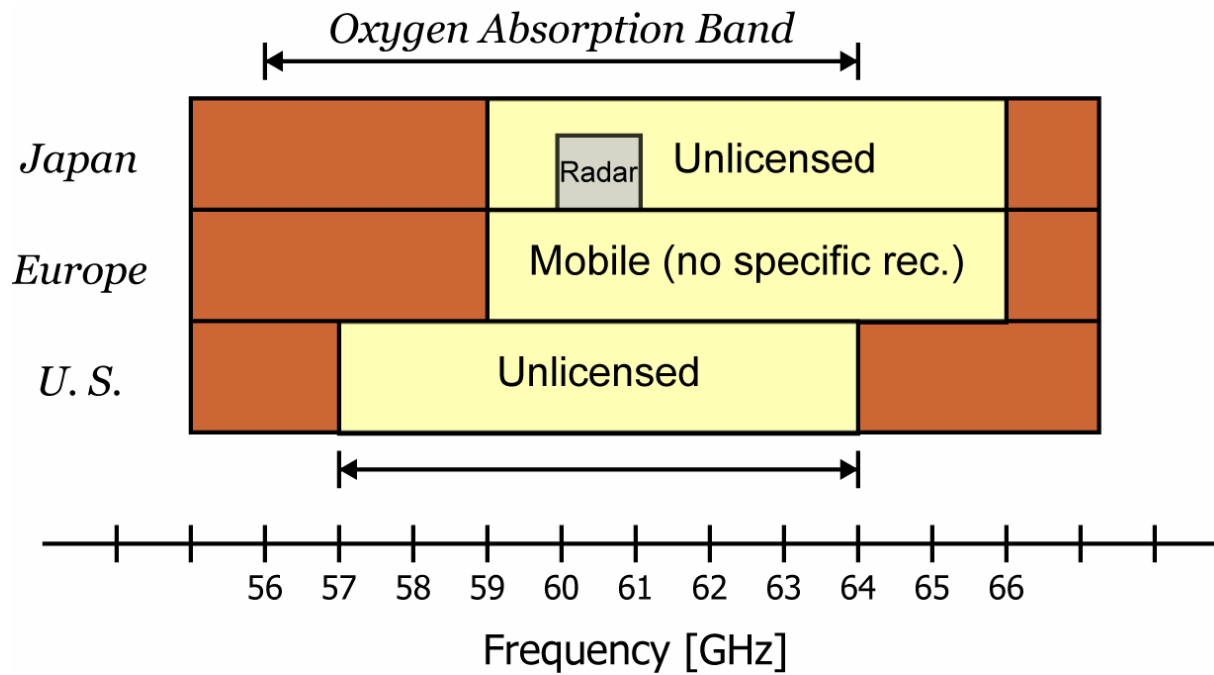

- 7 GHz of unlicensed bandwidth in U.S. and Japan
- High power levels (10 W EIRP)
- Like UWB wide bandwidth can compensate for channel loss

Millimeter wave radios

- Misconception 3: Implementing millimeter wave radios requires exotic materials
 - » Conventional state-of-the-art digital CMOS can be used to implement integrated radios up to 100 GHz
 - » Future technology scaling will allow even higher frequency operation (research is beginning into Terahertz operation)

60-GHz CMOS operation (130 nm)

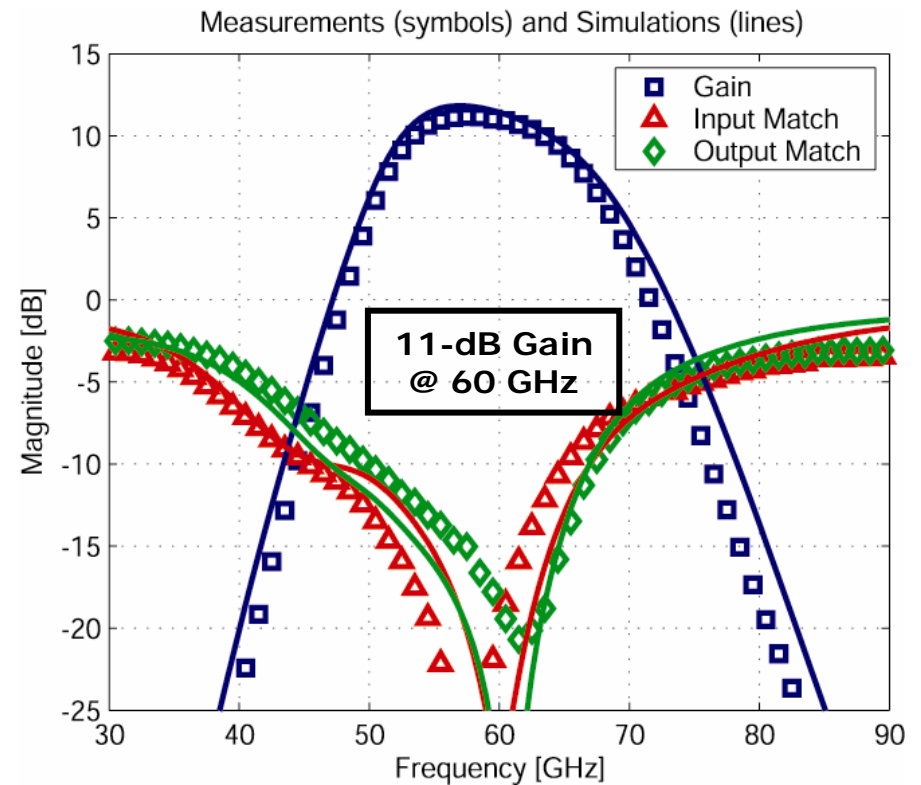
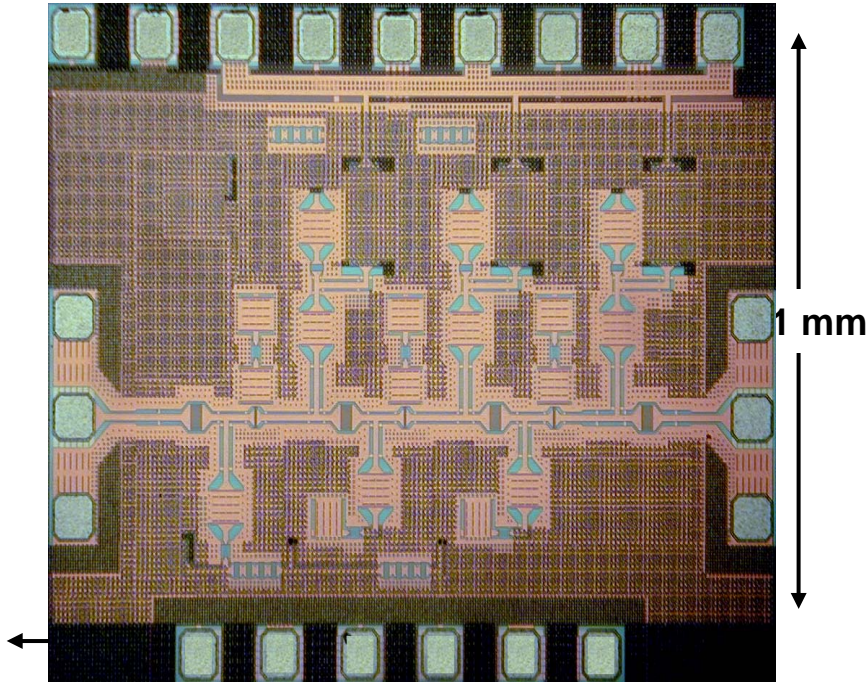

- Use of transmission line interconnect allows control of electrical and magnetic fields
- Better control than at lower frequencies!

60-GHz CMOS Receiver front-end

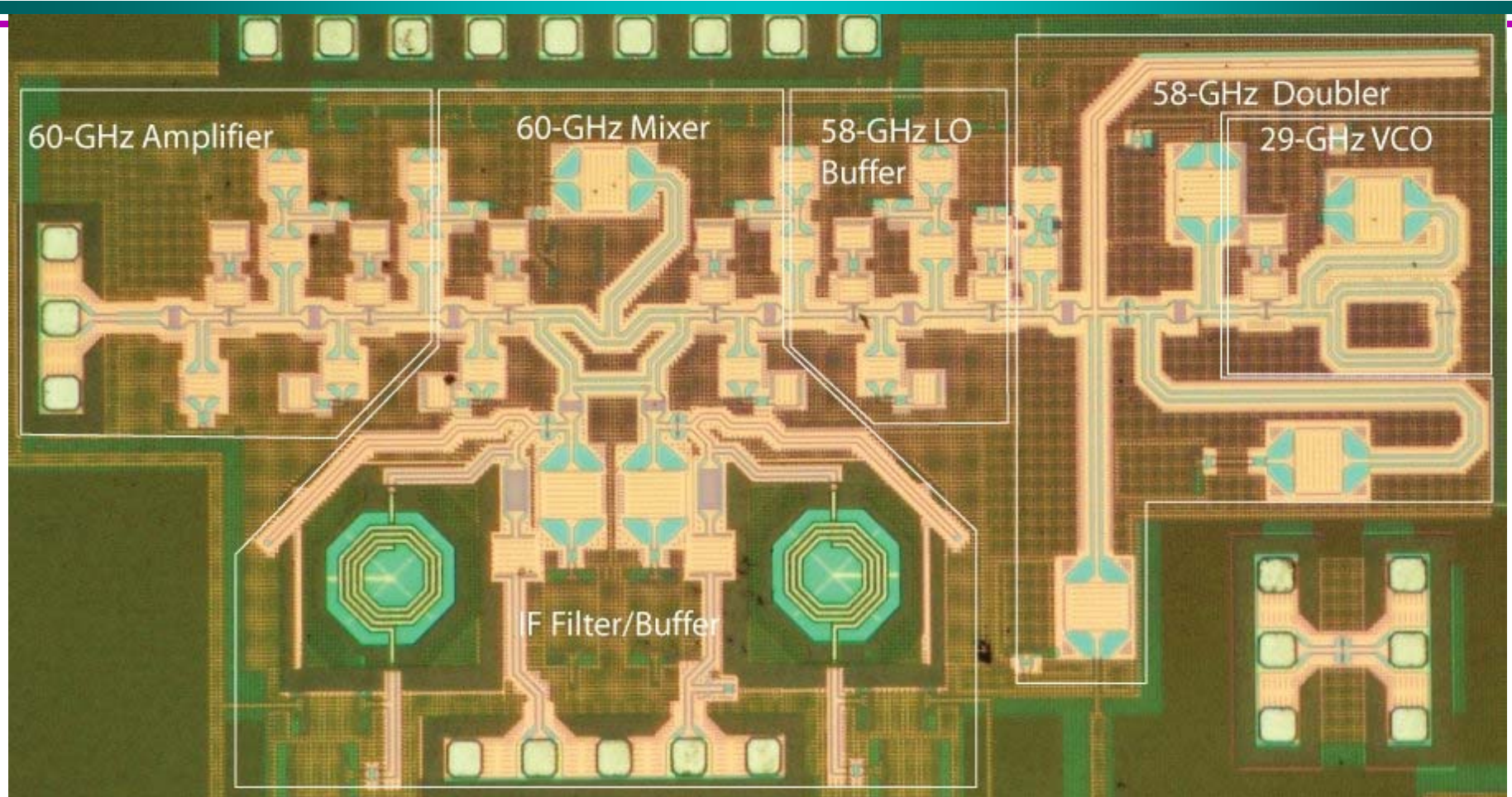

High levels of integration means a 60 GHz receiver could cost the same as a 2.4 GHz WiFi

Spectrum Created So Far

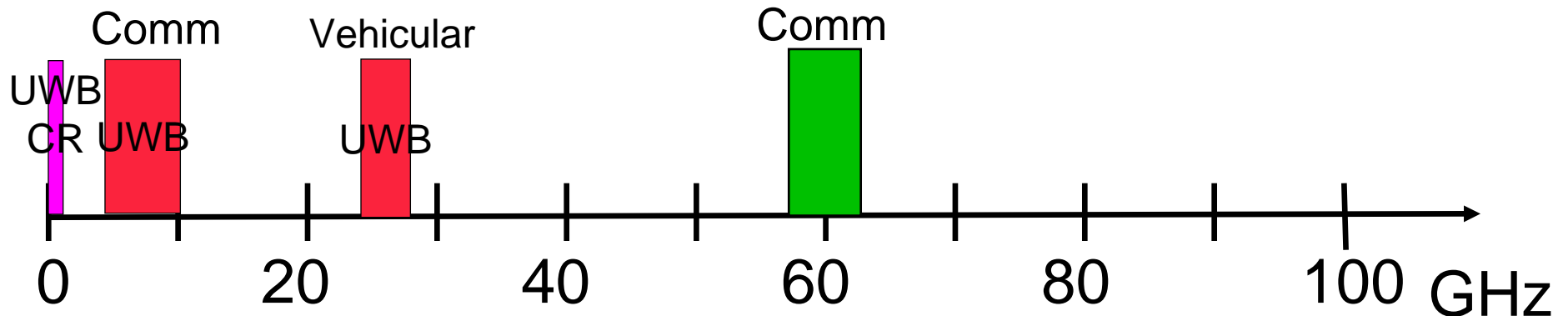

- 18 GHz of bandwidth has been “created”
- The regulators have been innovative, been much remains to transition to a new regulatory model
- It is possible to make a spectrum plot like the above obsolete

Conclusions

The solution to satisfying the demand for future wireless connectivity involves:

- A strategy that doesn't start with Spectrum Property rights and licensing
- Allowing new technology solutions that optimize over time, frequency and space to “create” new spectrum